



Kam Kiu Aluminium Products Group Limited

Content



-
-
-
-
-
-
-
-
-



Introduction



Kam Kiu Aluminium Group (KAP) is a leading aluminium extruder with a range of applications from consumer electronics, automotive, aerospace, marine, renewable energy system and to architectural projects. With 30+ years of expertise through billet casting, extrusion, die design, surface treatments to precision machining, KAP is committed to provide one stop solution to the market.

To provide technological support in aluminium products development, KAP devotes to research and development with capabilities proven to enhanced profiles performance solution and strengthen customers' product competitiveness.

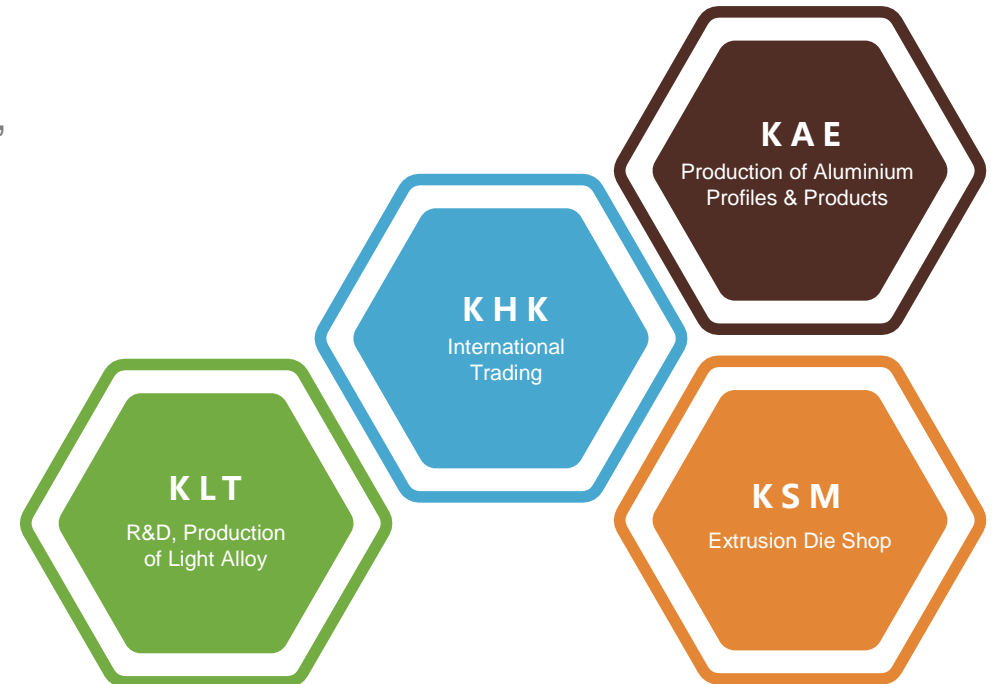

Milestones

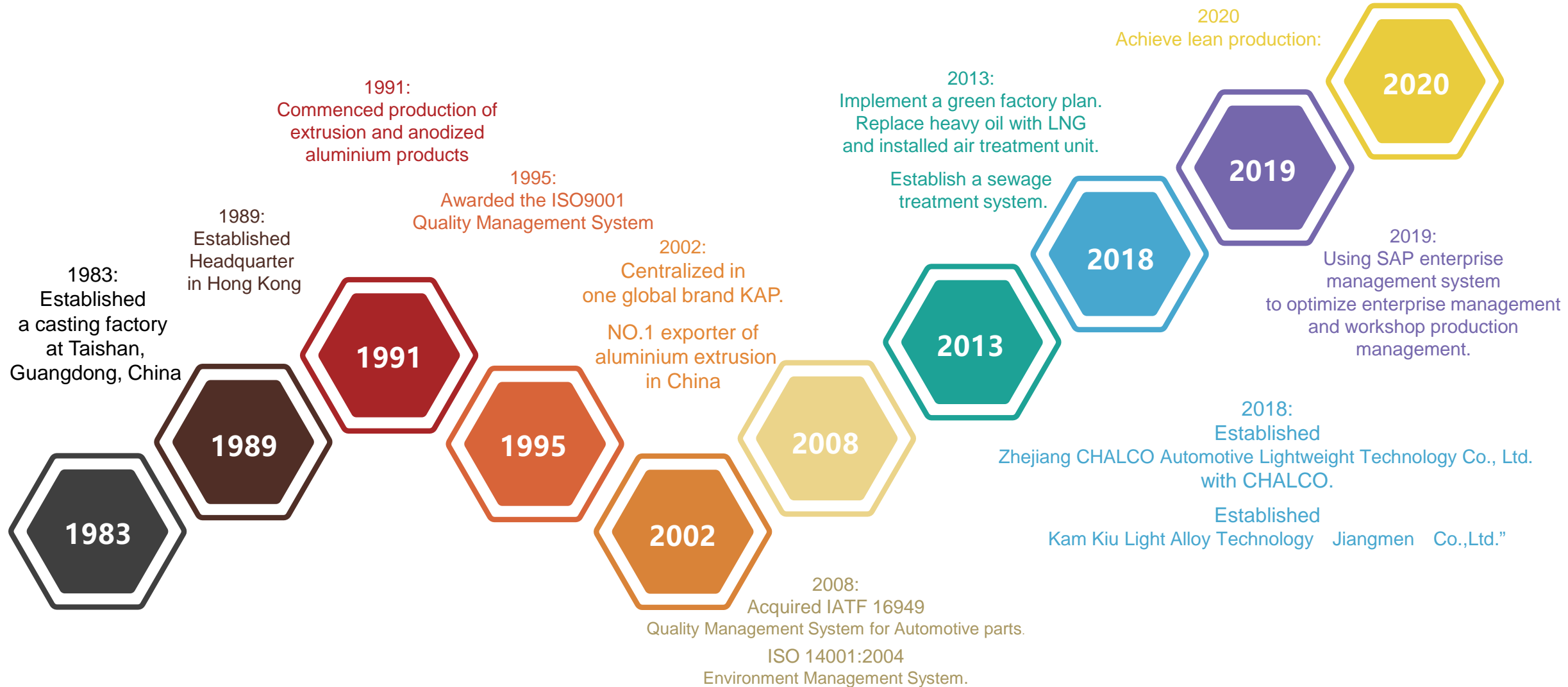

Our Vision



Core Values



Our Mission



Sustainability



Environmental Protection

This is our home... Taishan, China, Earth.



Recycling

The aluminum products we produce every day will be the "Recycled aluminum."



Occupational Health and Safety (OHS)

As a result, we have succeeded in continuously reducing the number of accidents at work.



Social Responsibility

We want to make "happiness" become the corporate culture of KAP.



Certification

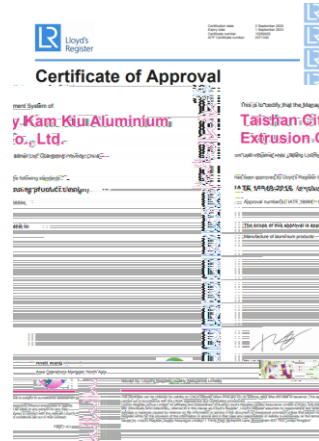

Certification

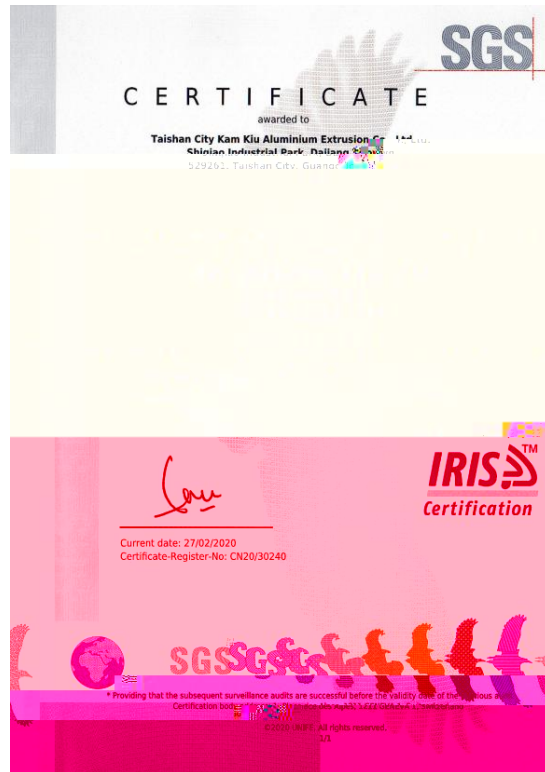

ISO/TS 22163:2017

Railway Quality Management System

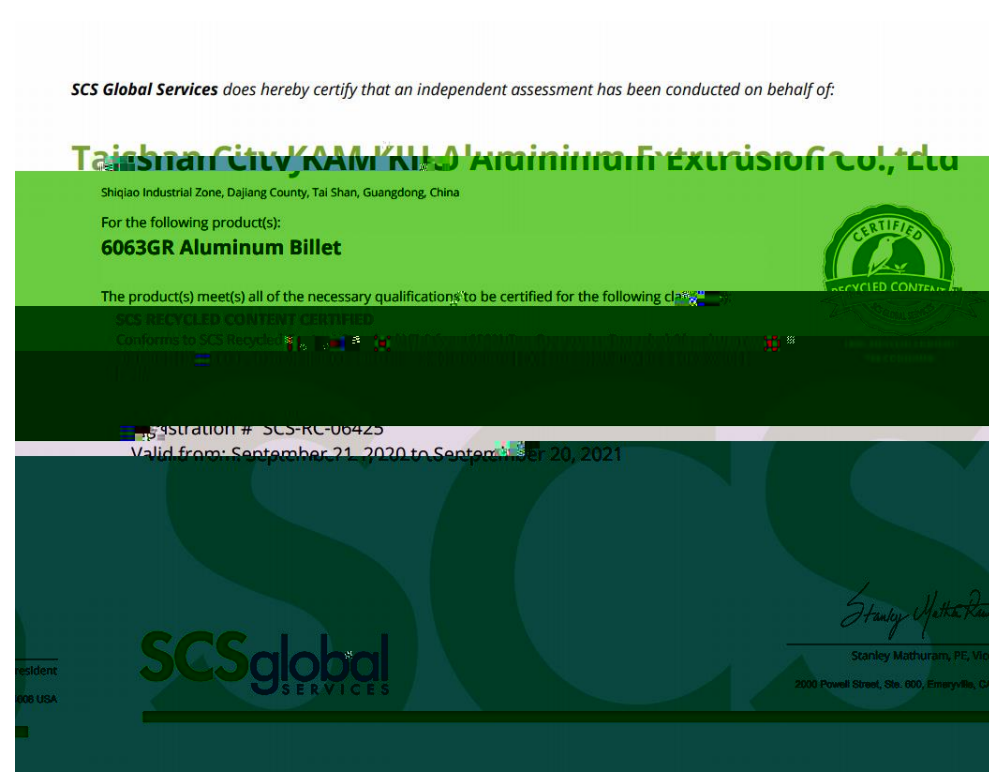

SCS Recycled aluminum product certification

Distribution by Region

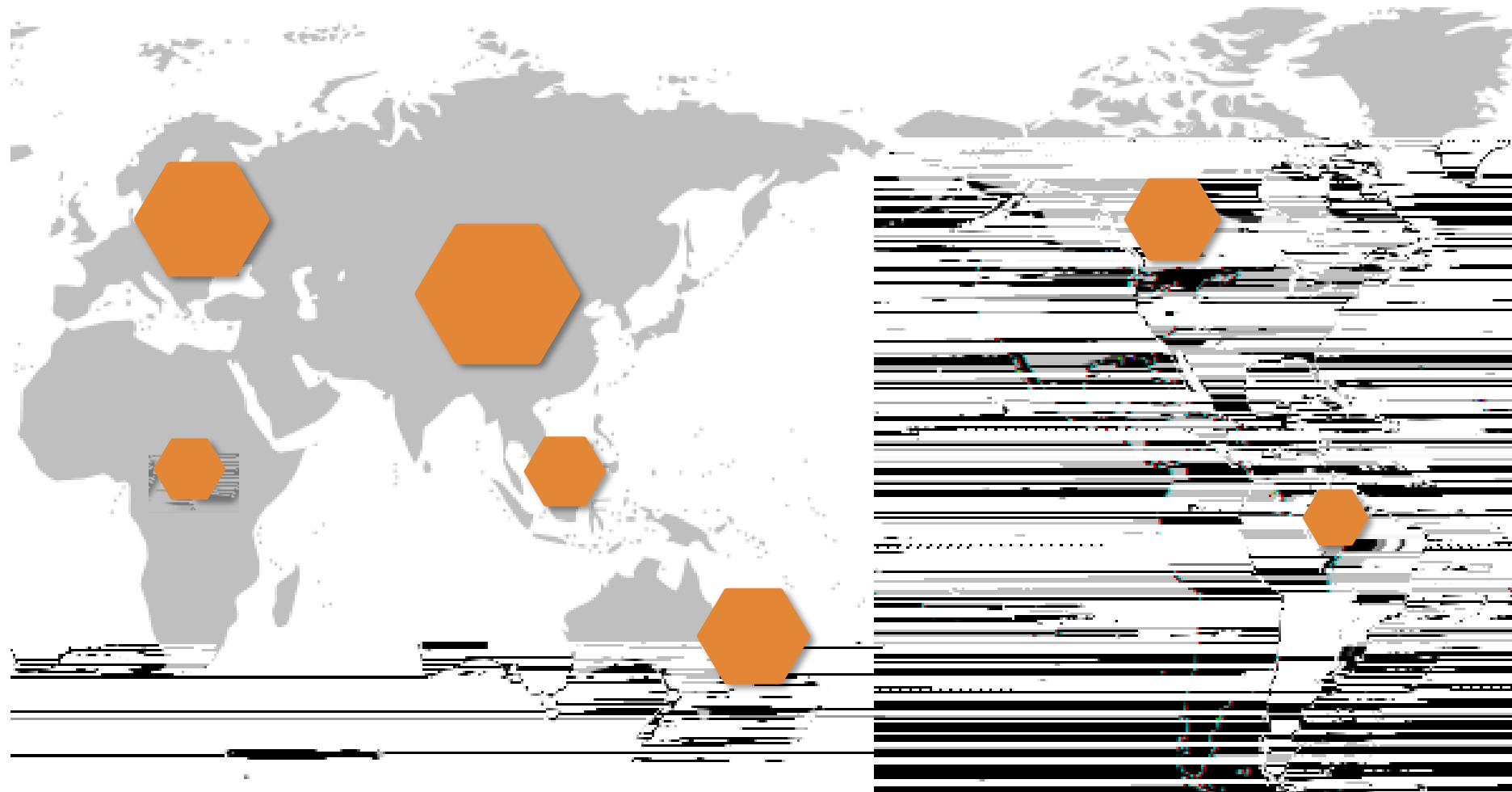

Products & Applications



Building & Construction

Industrial

Life Improvement

Industrial Profiles (85%)

Widely used in the following industries:
3C Electronics,
Auto Parts, Transportation,
Industrial Production,
Medical Equipment...

Architecture Profiles (15%)

Widely used in the following industries:
Curtain wall, Doors & Windows,
Construction Work
Home settings, Shower Enclosure...

Transportation

Automotive

3C Electronics

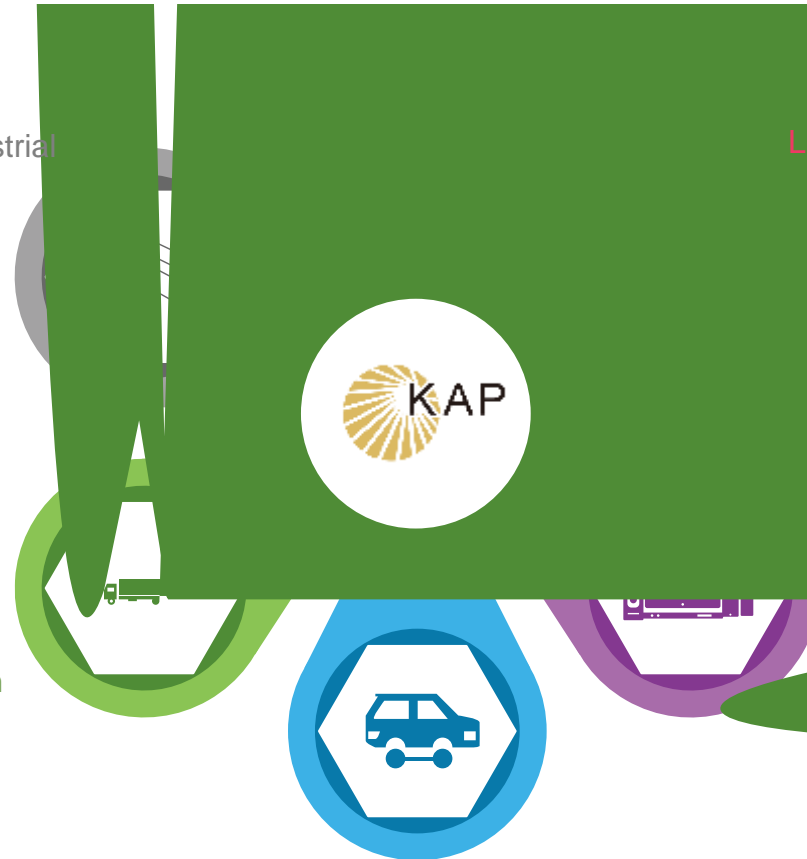

Building & Construction

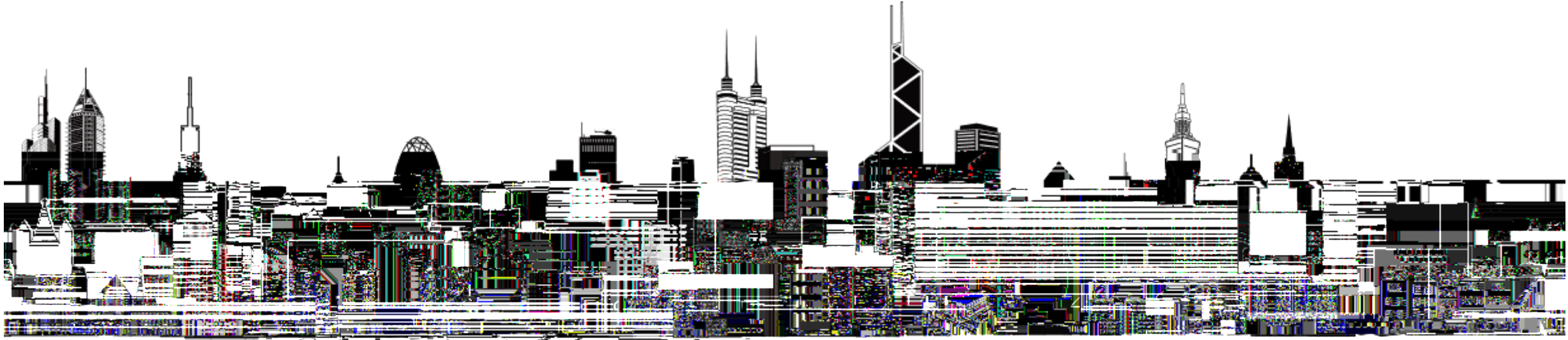

3C Electronics



KAP



Automotive

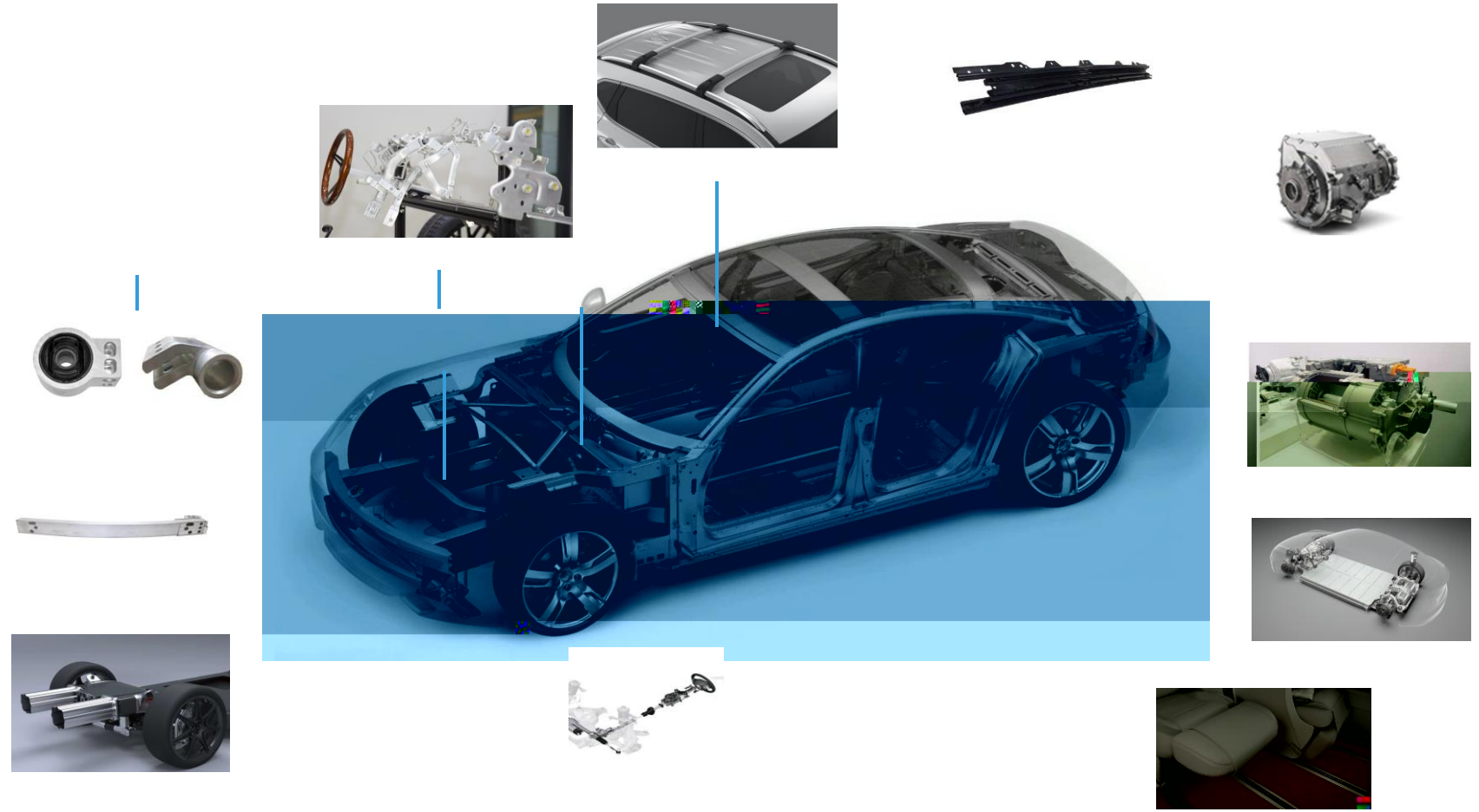

Transportation

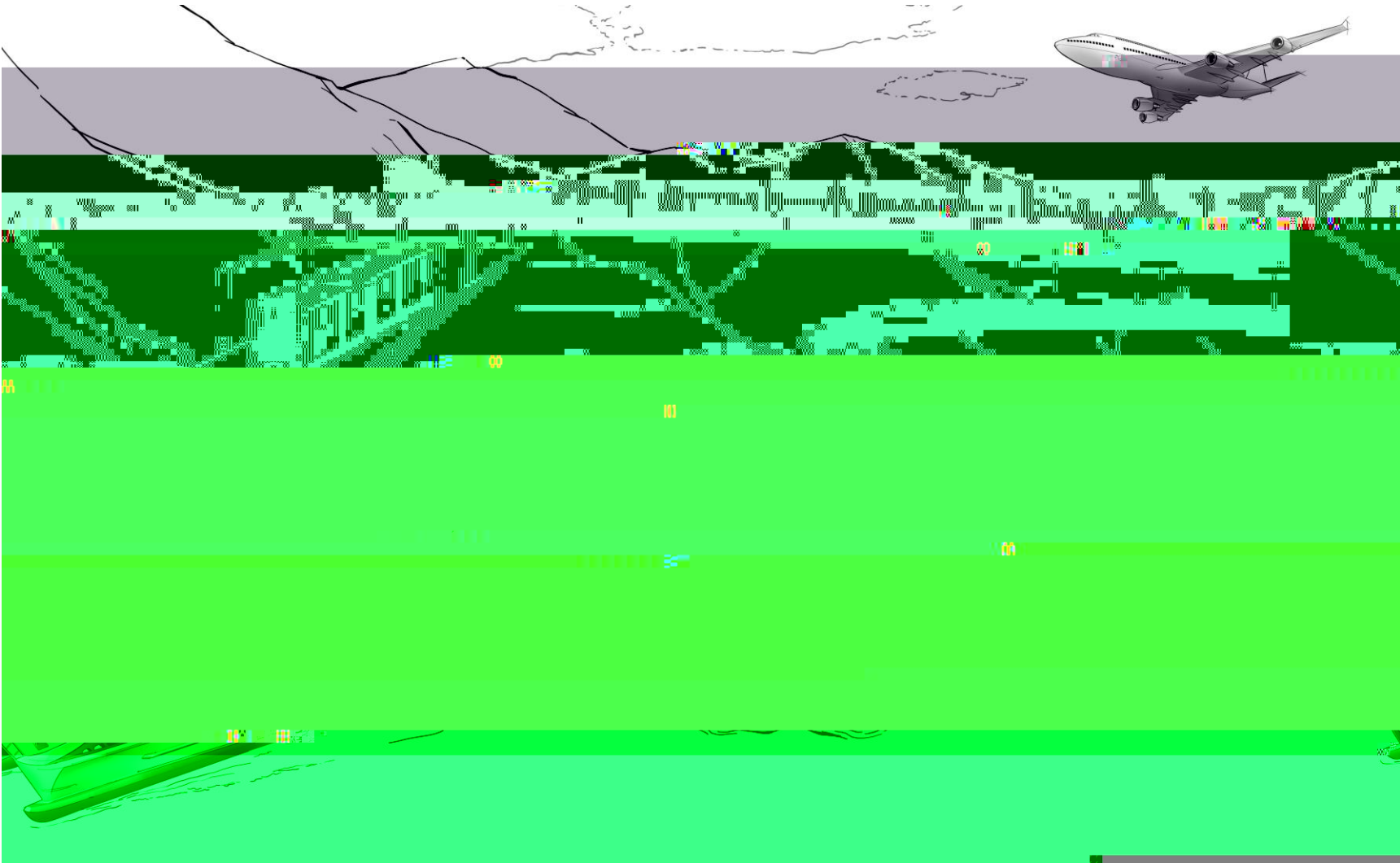

Life Improvement

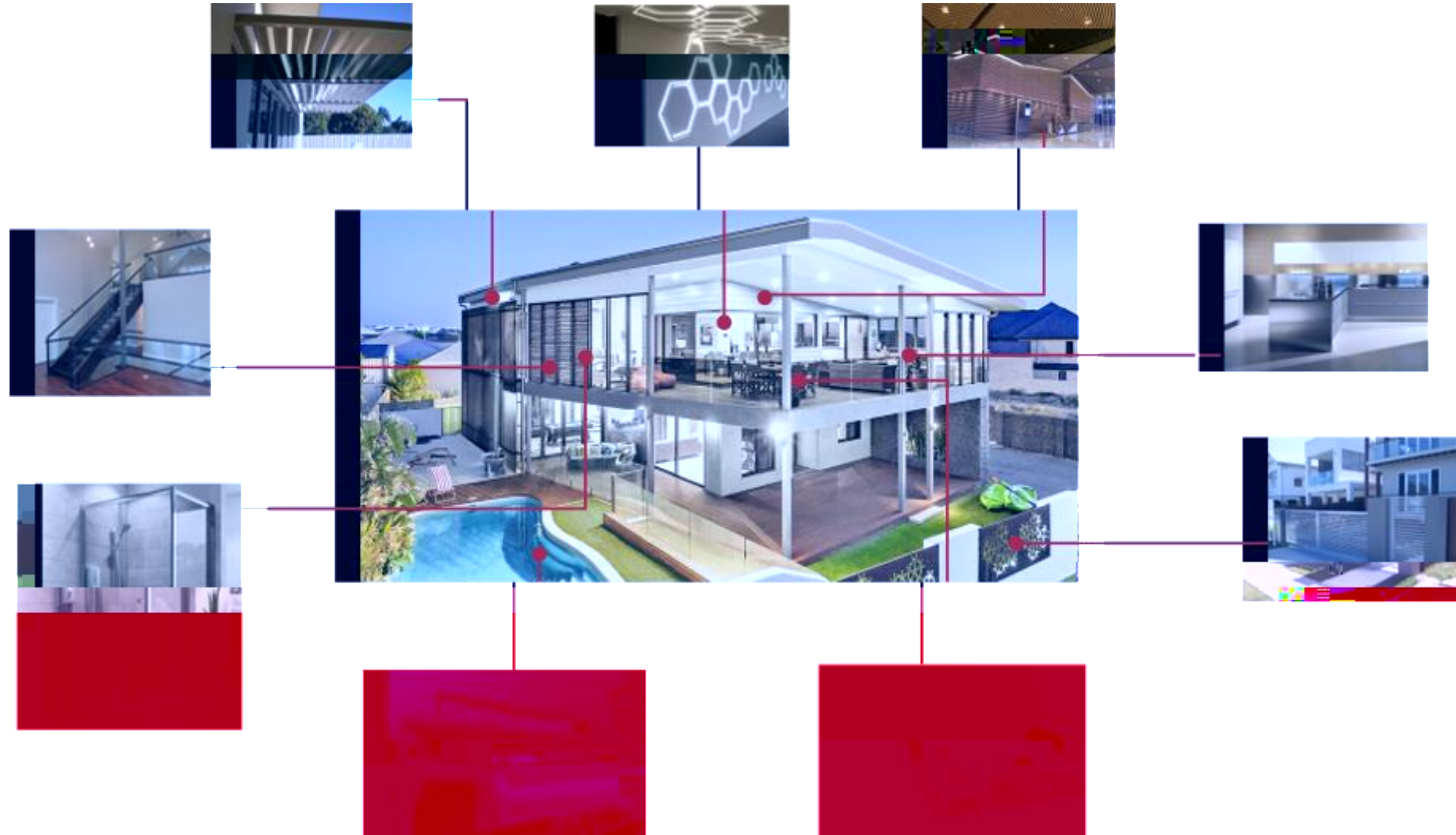

Industrial



Rod & Bar



Industrial Profiles

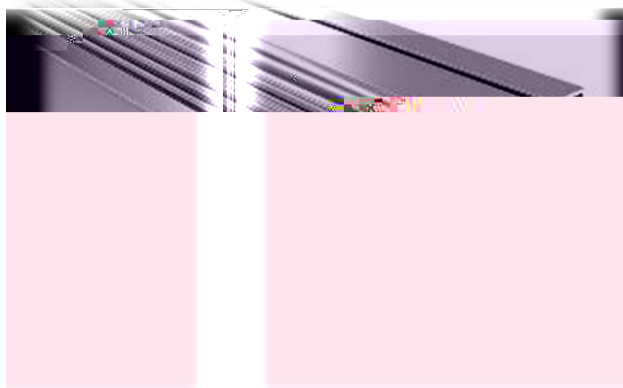

Standard Profiles



Assembly Technology Profiles



Production Base



Taishan City Kam Kiu Aluminium Extrusion Co., Ltd. (KAE)

- Location: Taishan, Guangdong, China.
- Establishment date: Year 1983
- Area: 389,000sqm.
- Number of employees: ~2500.

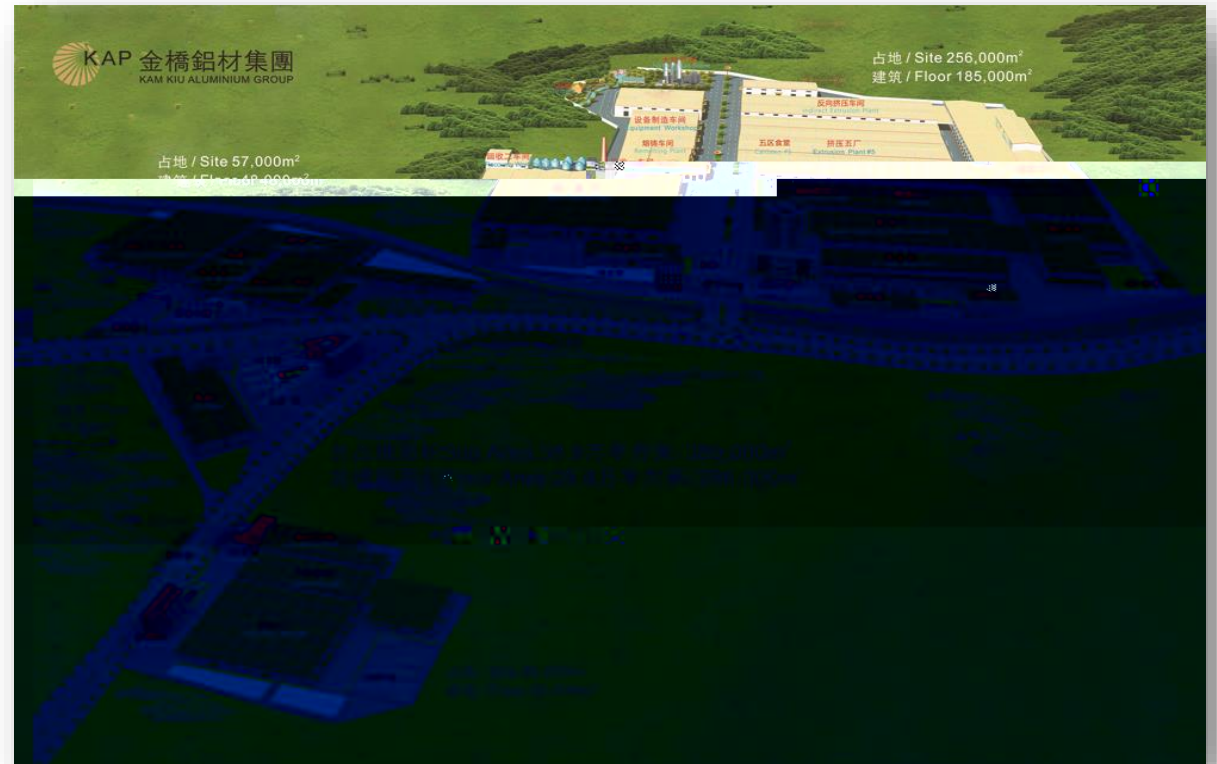

Production Base



Kam Kiu Light Metal Technology Co., Ltd. (KLT)

- Location: Taishan, Guangdong, China.
- Establishment date: Year 2018
- Area: 166,500sqm.
- Number of employees: ~800.





In-house Die shop



Aluminium Billet Casting

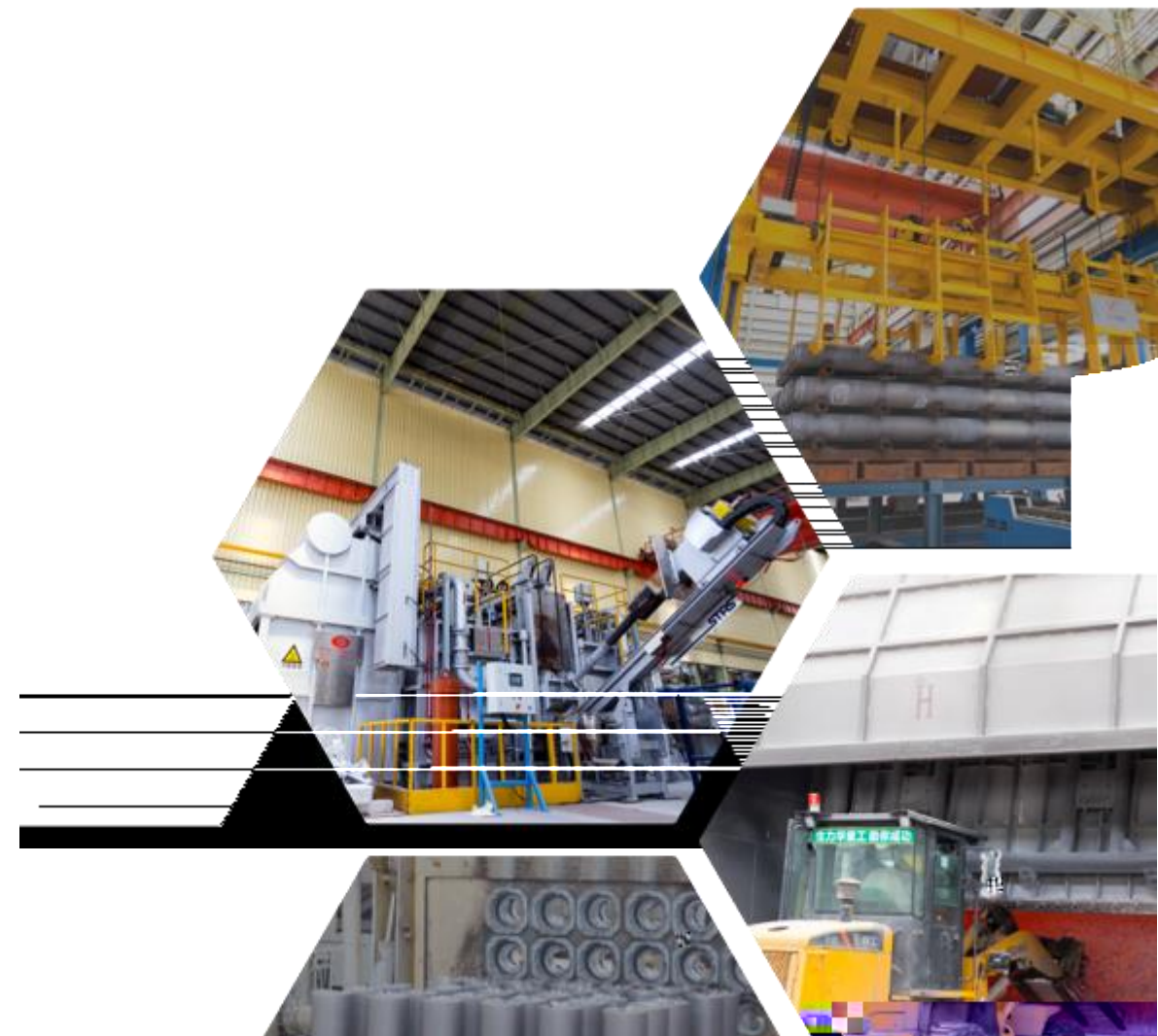

-
-
-



Extrusion Profile





Surface Finishing

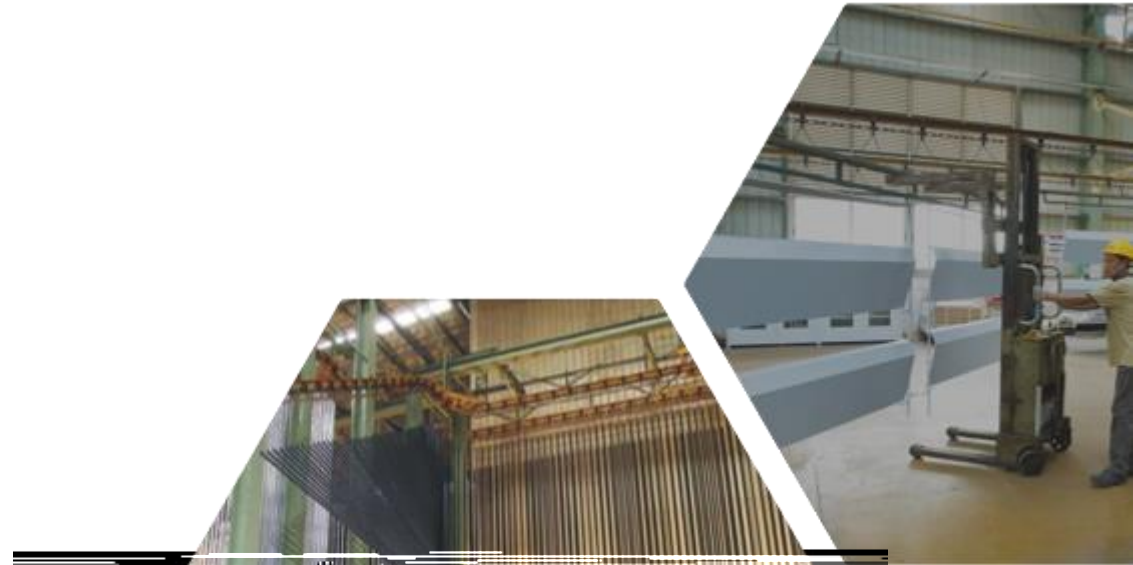

-
-
-
-
-
-
-

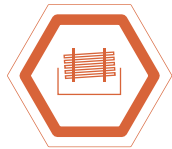

Precision Machining



-
-
-
-
-
-
-
-



Automotive Parts Production



Quality Control



- -
 -
 -
 -
 -
 -
 -
- -
 -
 -
 -

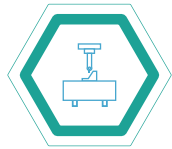

Research & Development

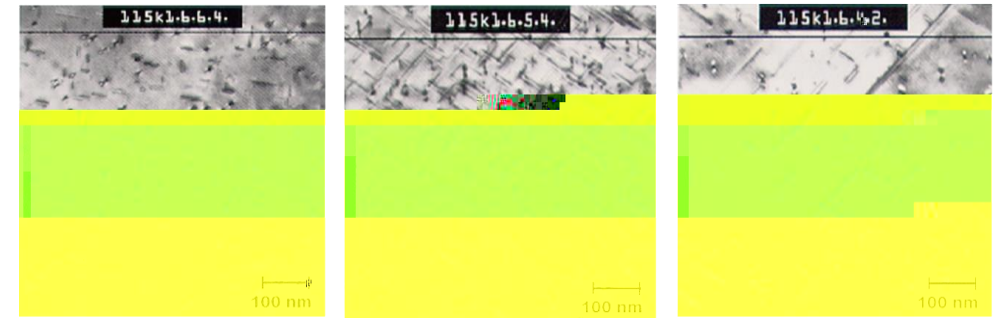

Under-aged Peak aged Over-aged

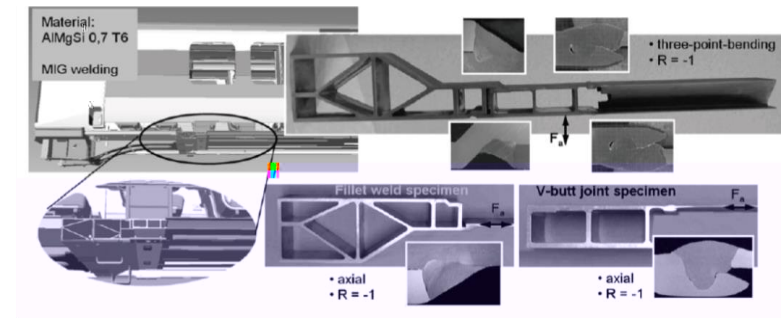



Thank you very much !