



兴福铝材集团有限公司

(& 3C)

(KAE, KLT)

(
)

KAP

KAP



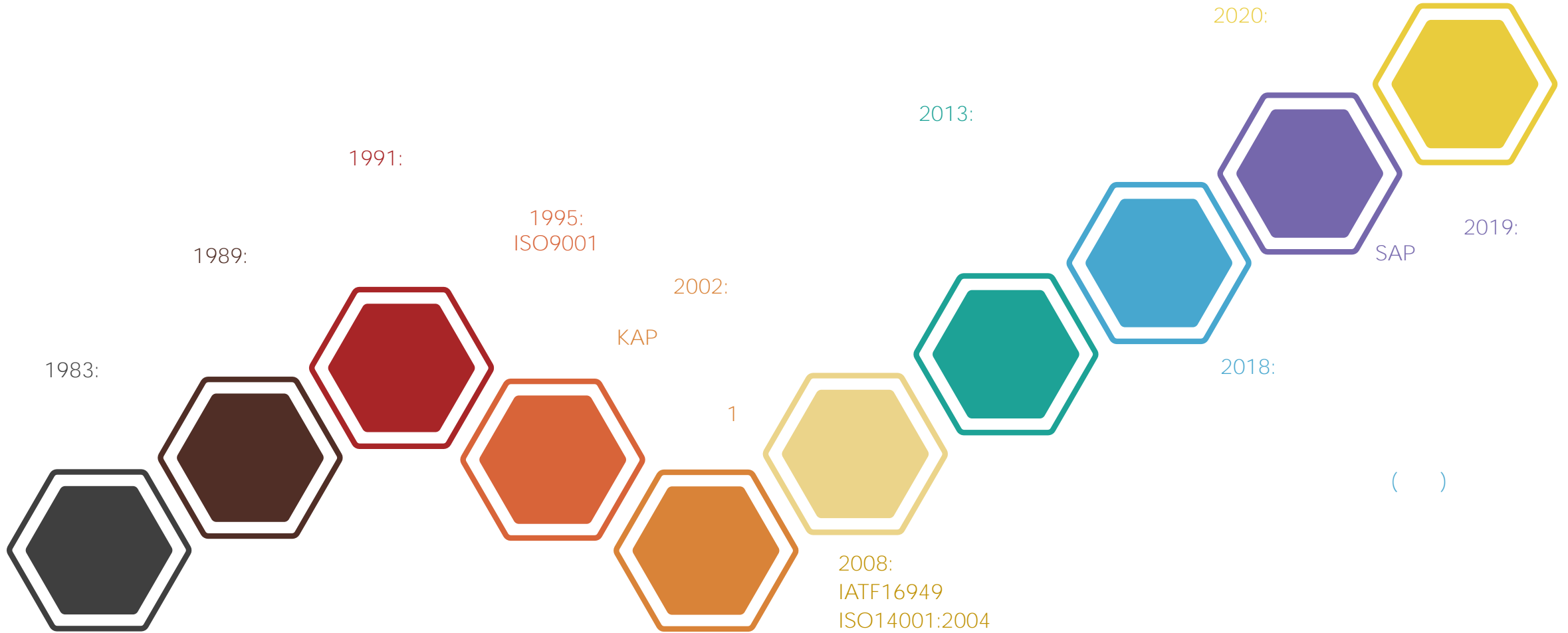

()

世界中の全ての人に金橋の製品を少なくとも1つ持ってほしい。

力を合わせて、金橋を中国の金橋又は世界の金橋に育てる。

金橋の社員たちは前向きに進み、

「百年金橋」という目標の達成に向かって、取り組む。

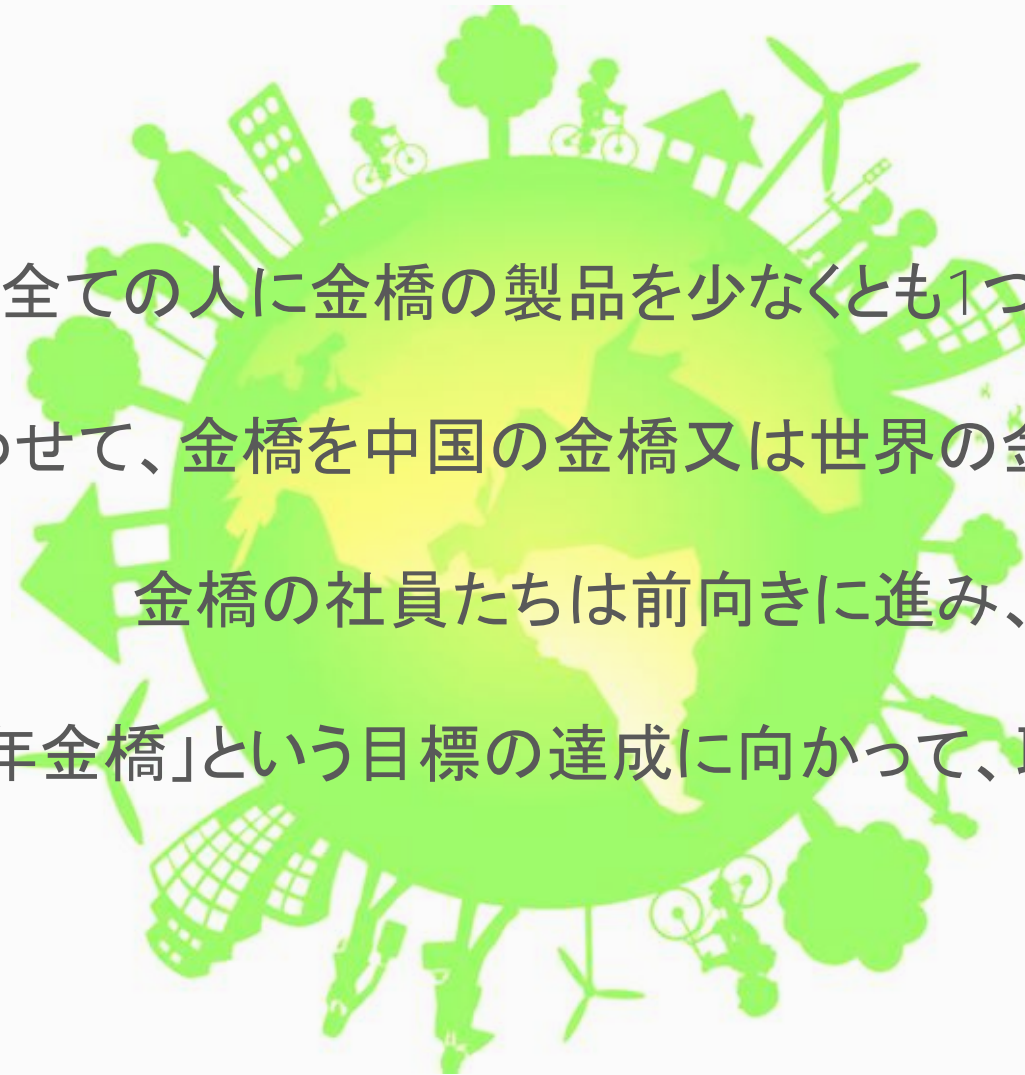

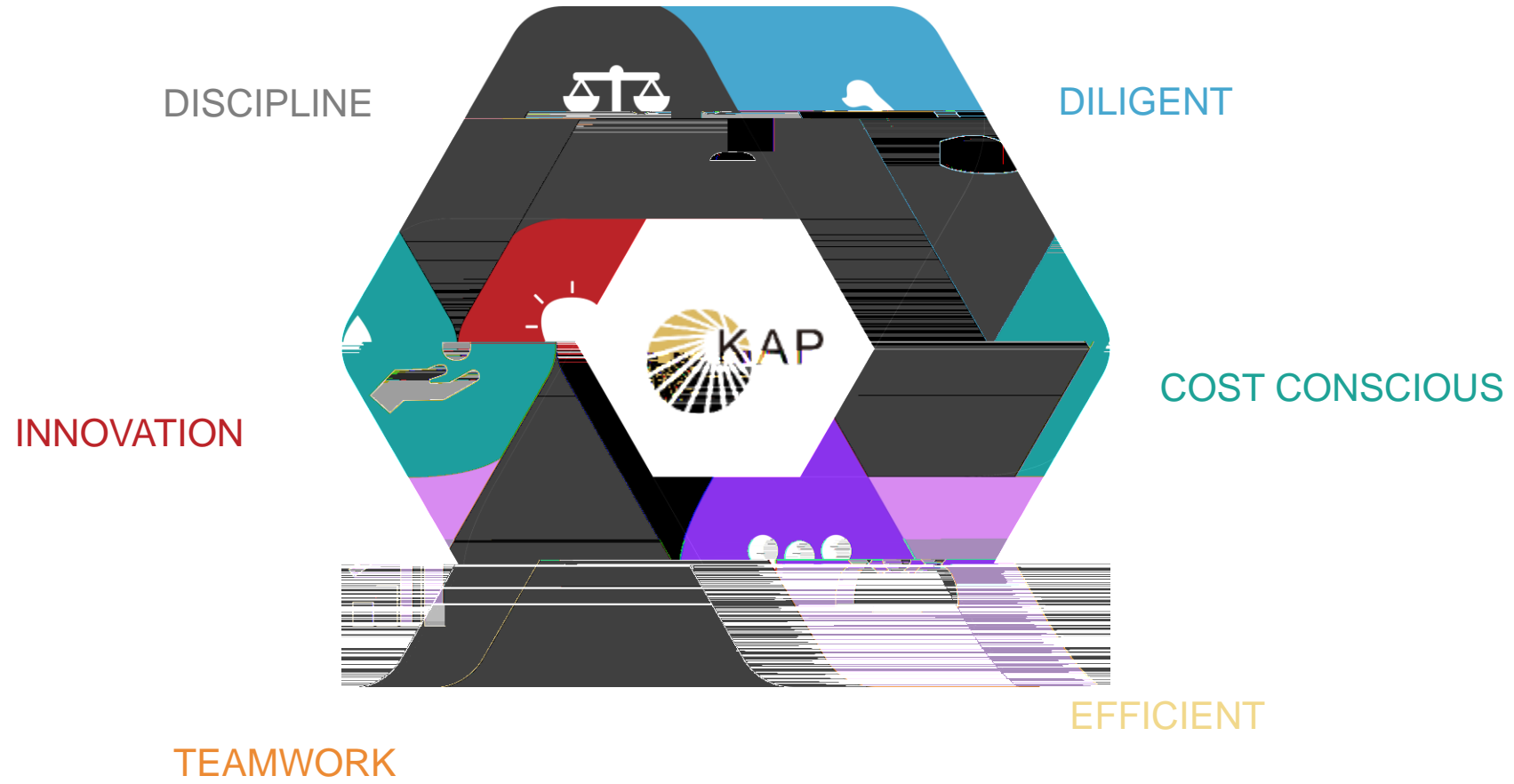

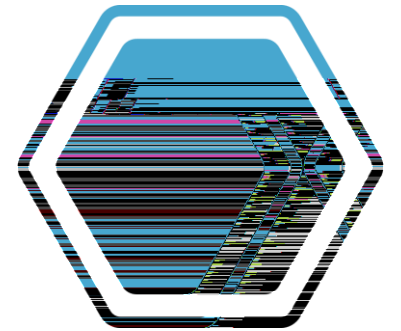
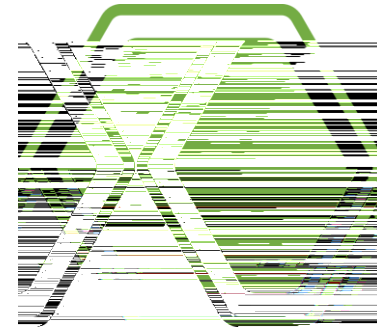
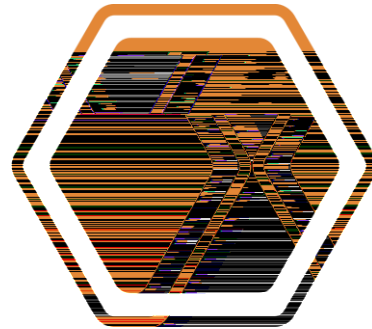

KAP

1

KAP

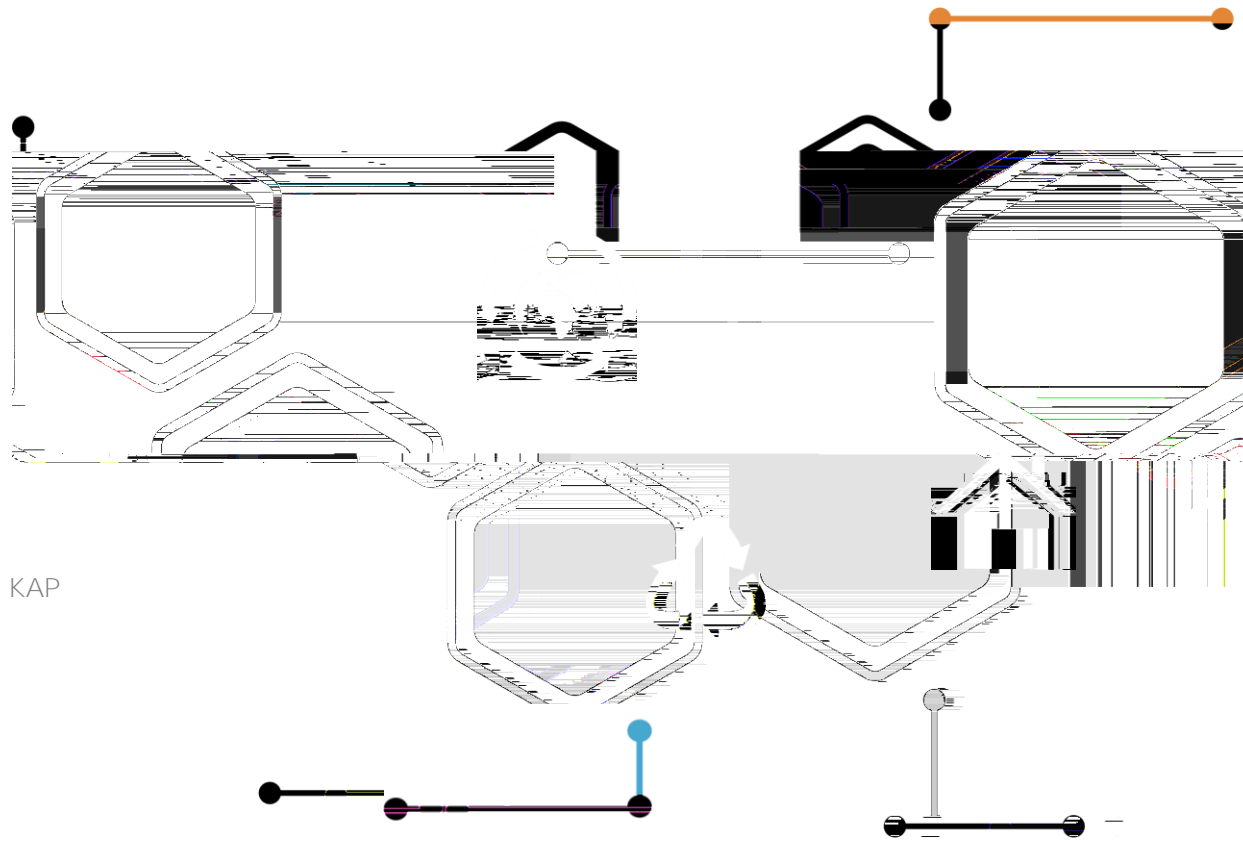

KAP

1

30

ISO 9001:2015

IATF 16949:2016

ISO 14001:2015
GB/T 24001:2016

ISO 45001:2018

DNV

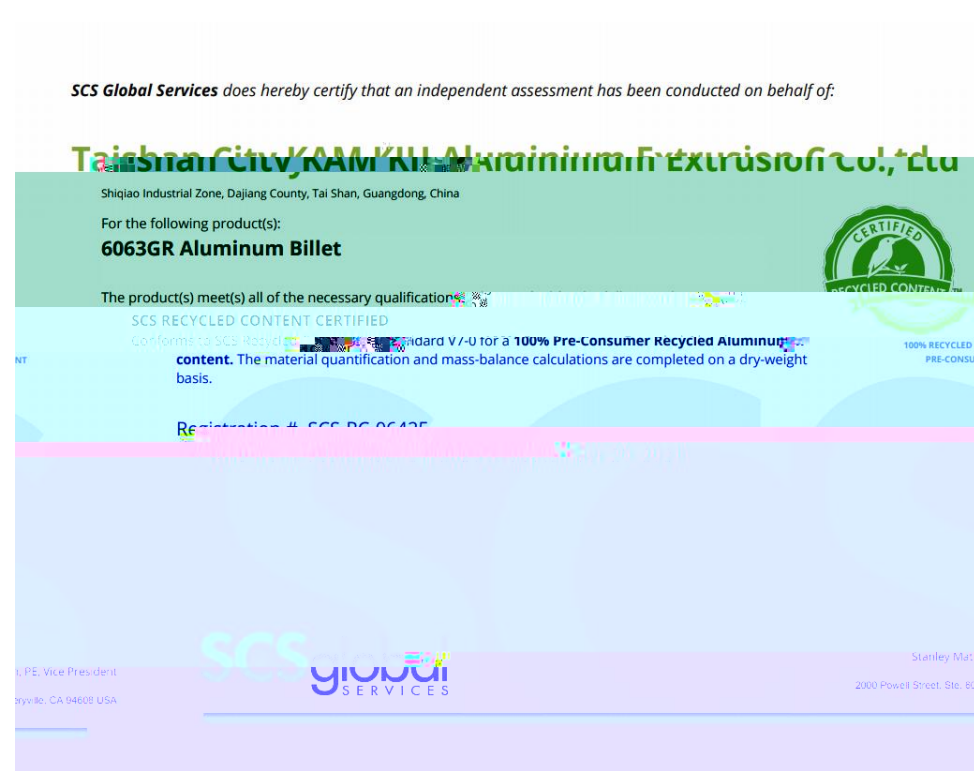
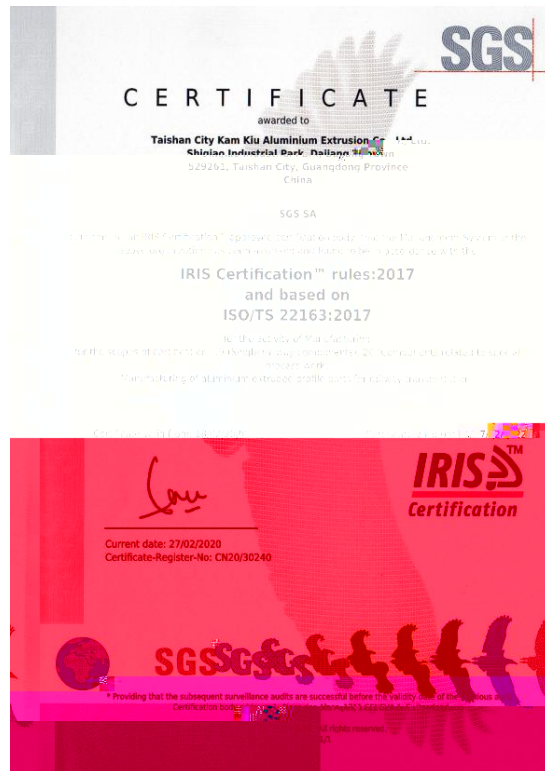

SCS

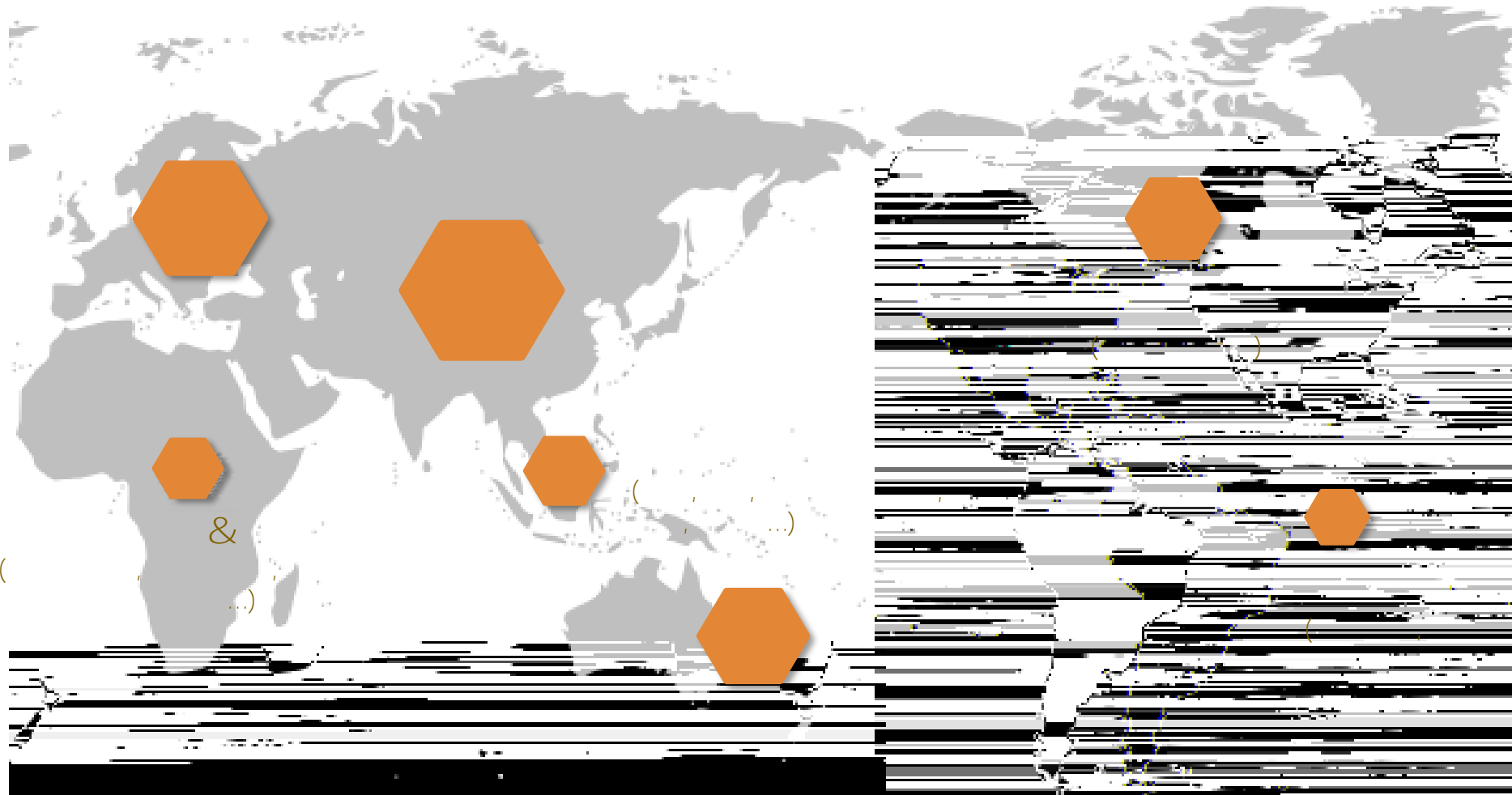

&

(85%)
3C

...
:



3C

(15%)

...
:

&

30

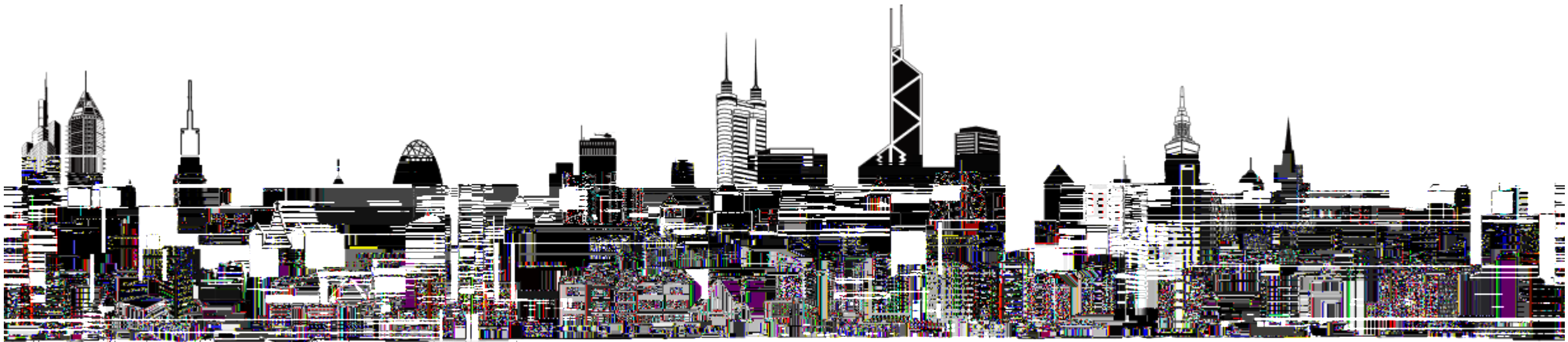

3C



7XXX

70

10

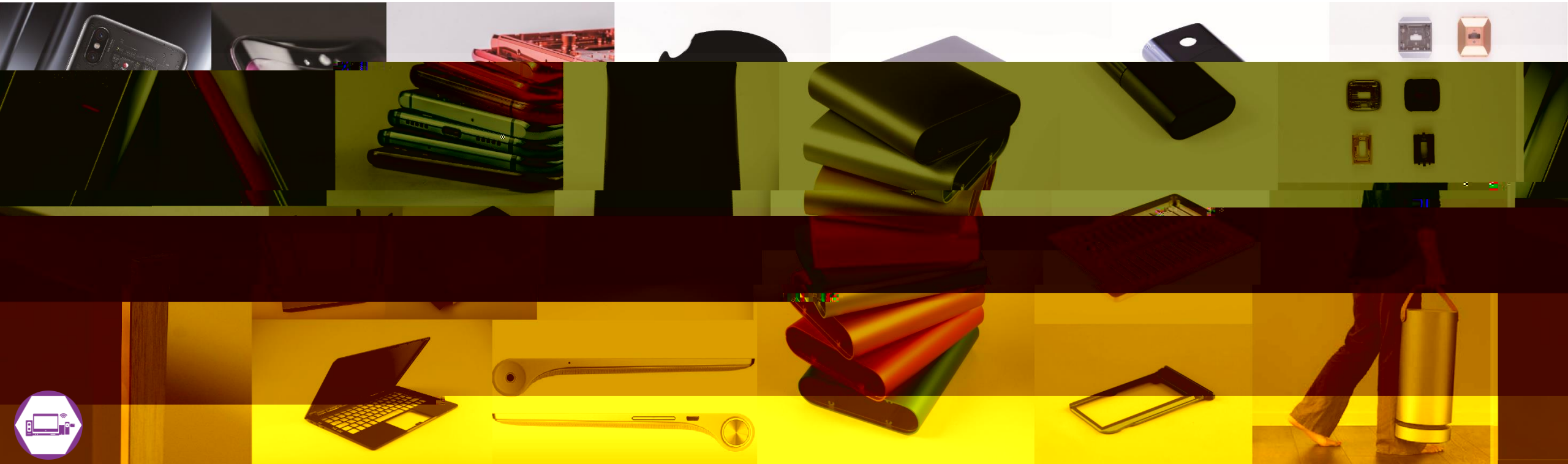



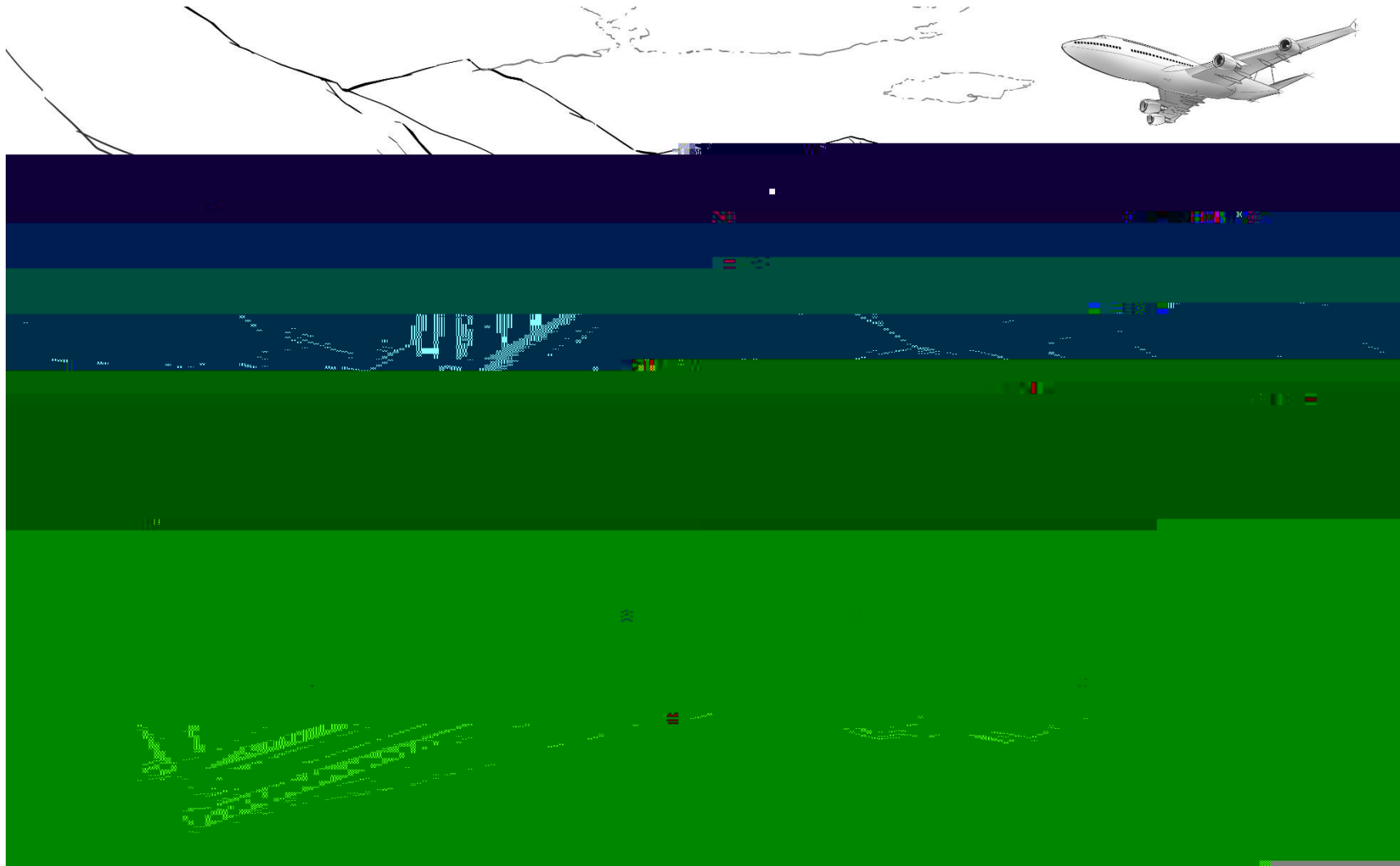

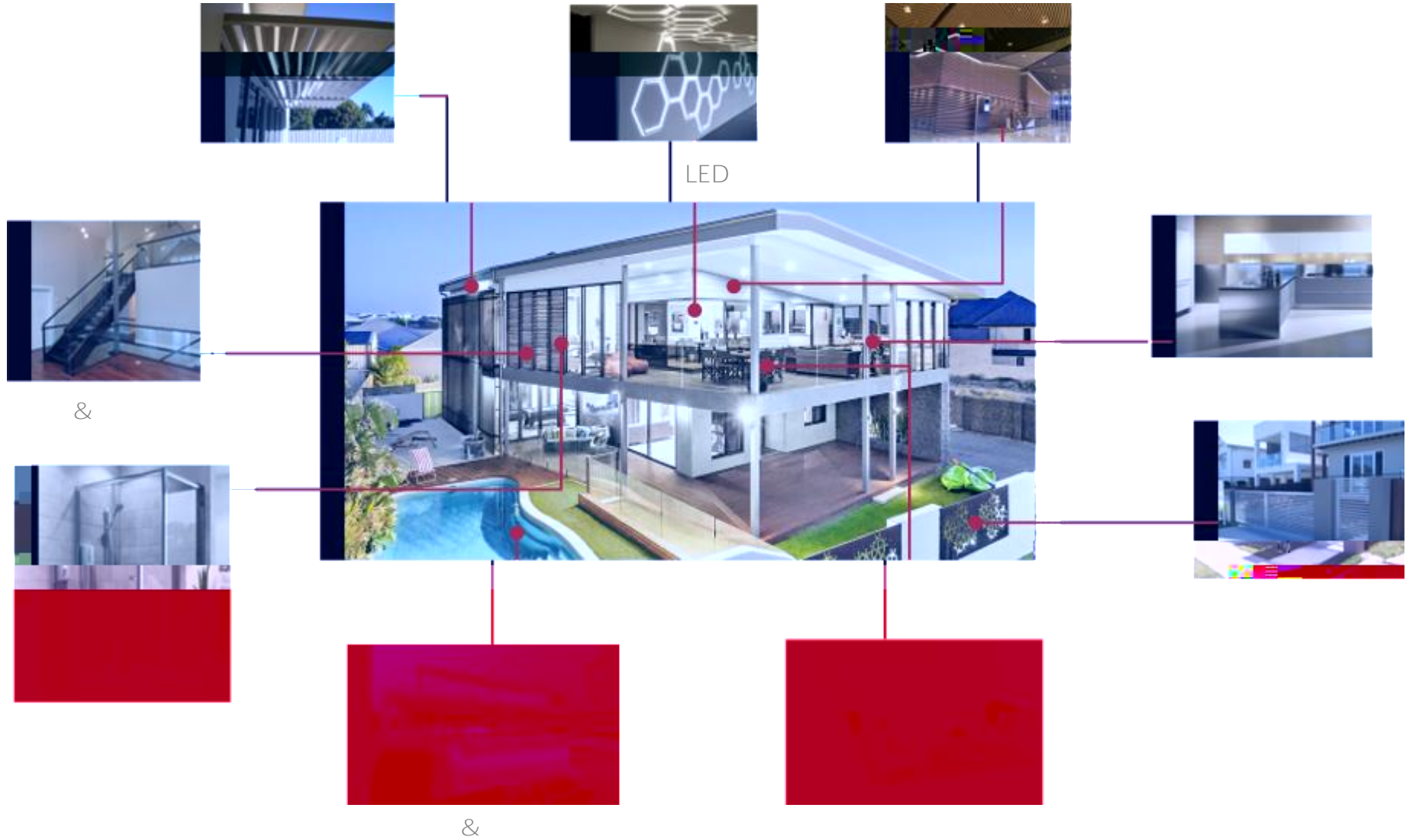



&

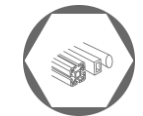
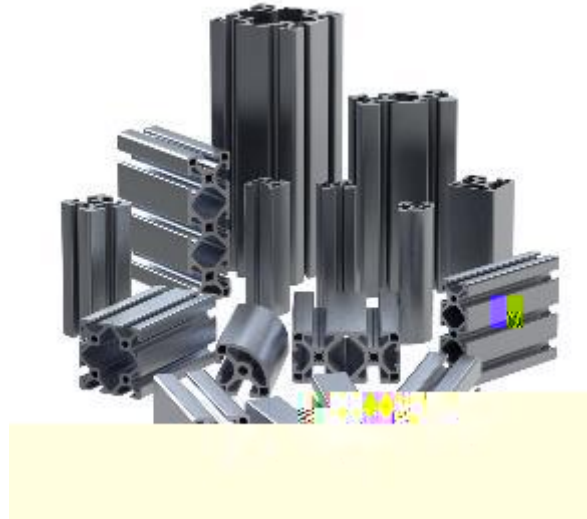
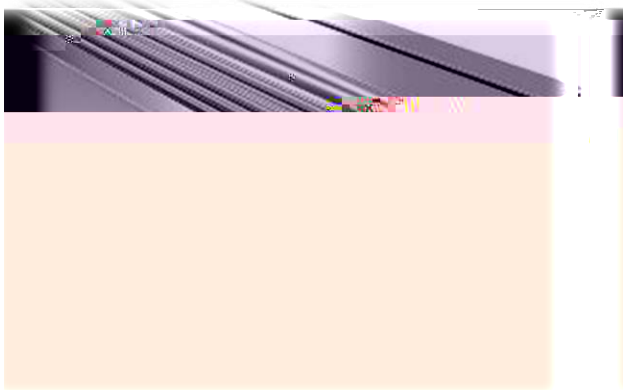

(KAE)

:

: 1983

: 389,000sqm.

: ~2500.



() (KLT)

:

: 2018

: 166,500sqm.

: 800

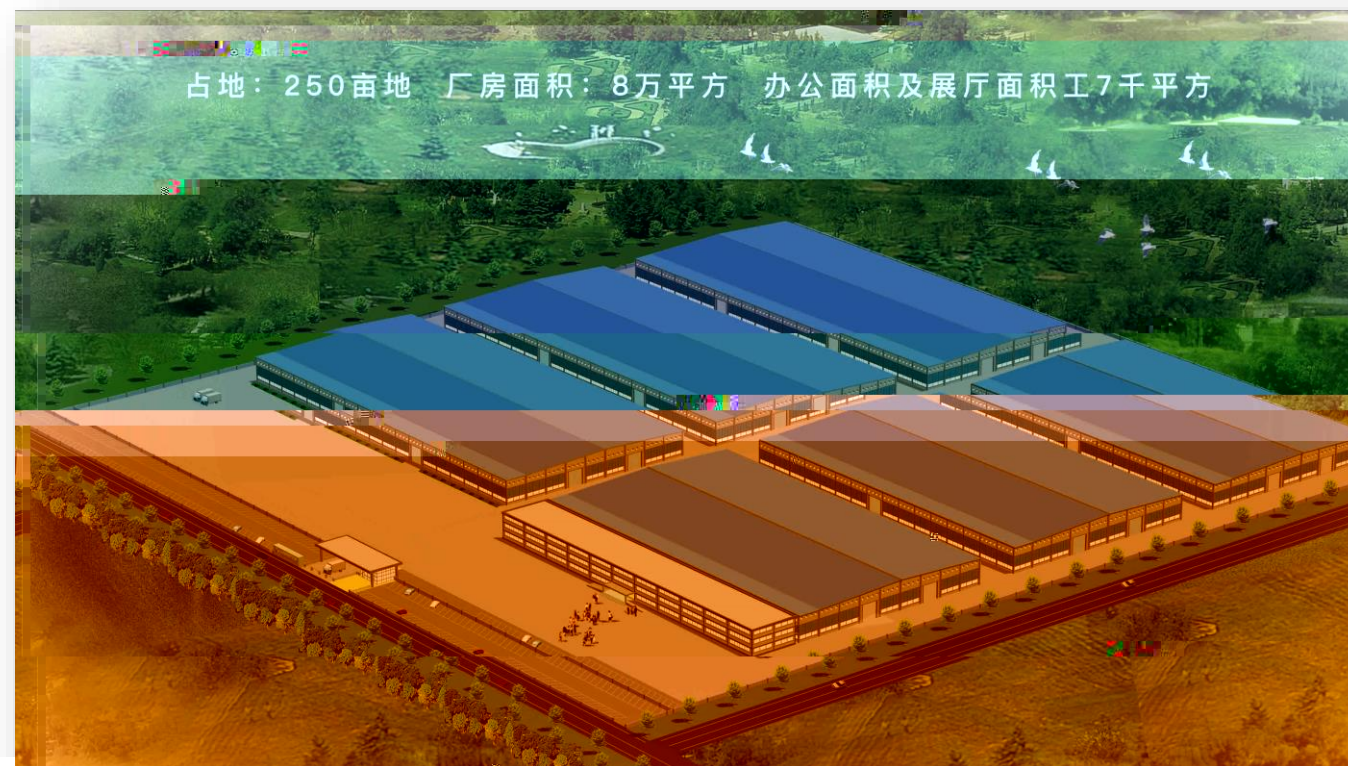

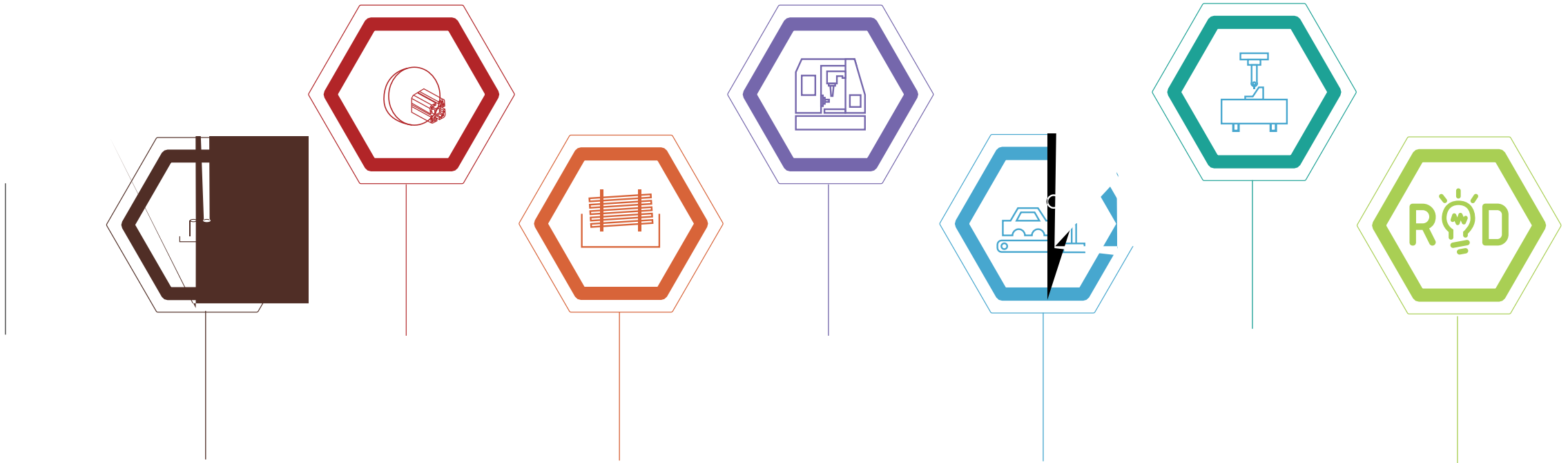

KAP 1

3D

CNC



KAP

99.7%

1xxx 2xxx 3xxx 5xxx 6xxx 7xxx

LNG

16

	35	30	25	20
	1	4	9	2

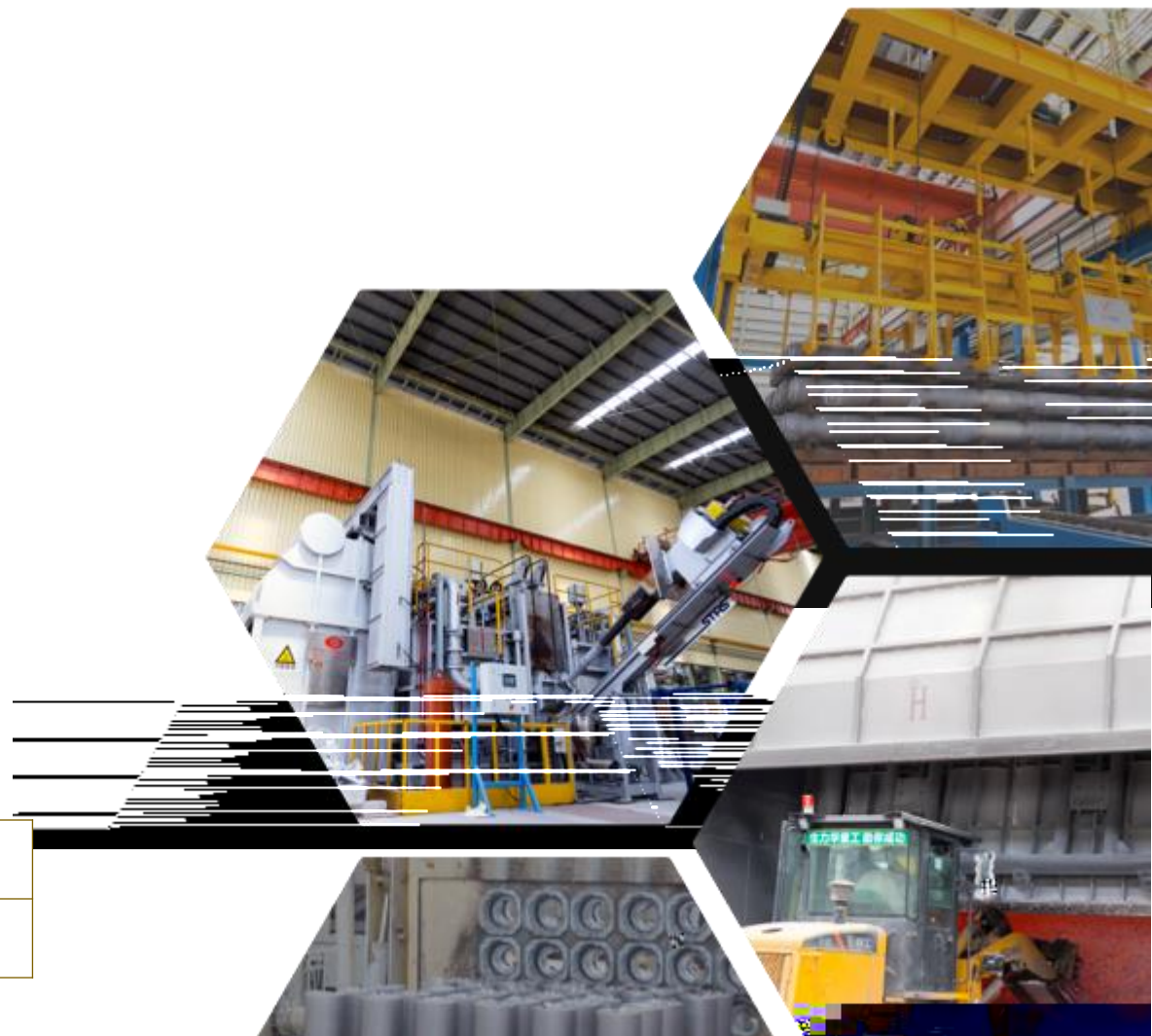



KAP

-
-
-
-
-
-
-

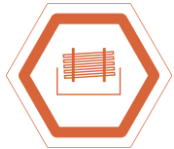
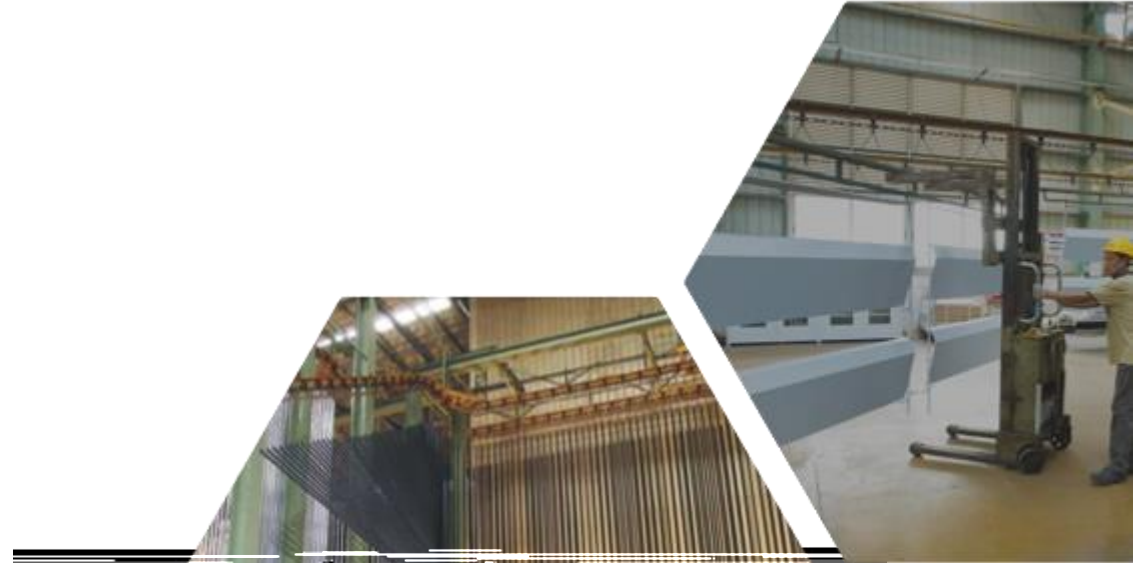

KAP

2017

<IATF16949

>

SAP



KAP

-
-
-
-
-
-
-

- CMM

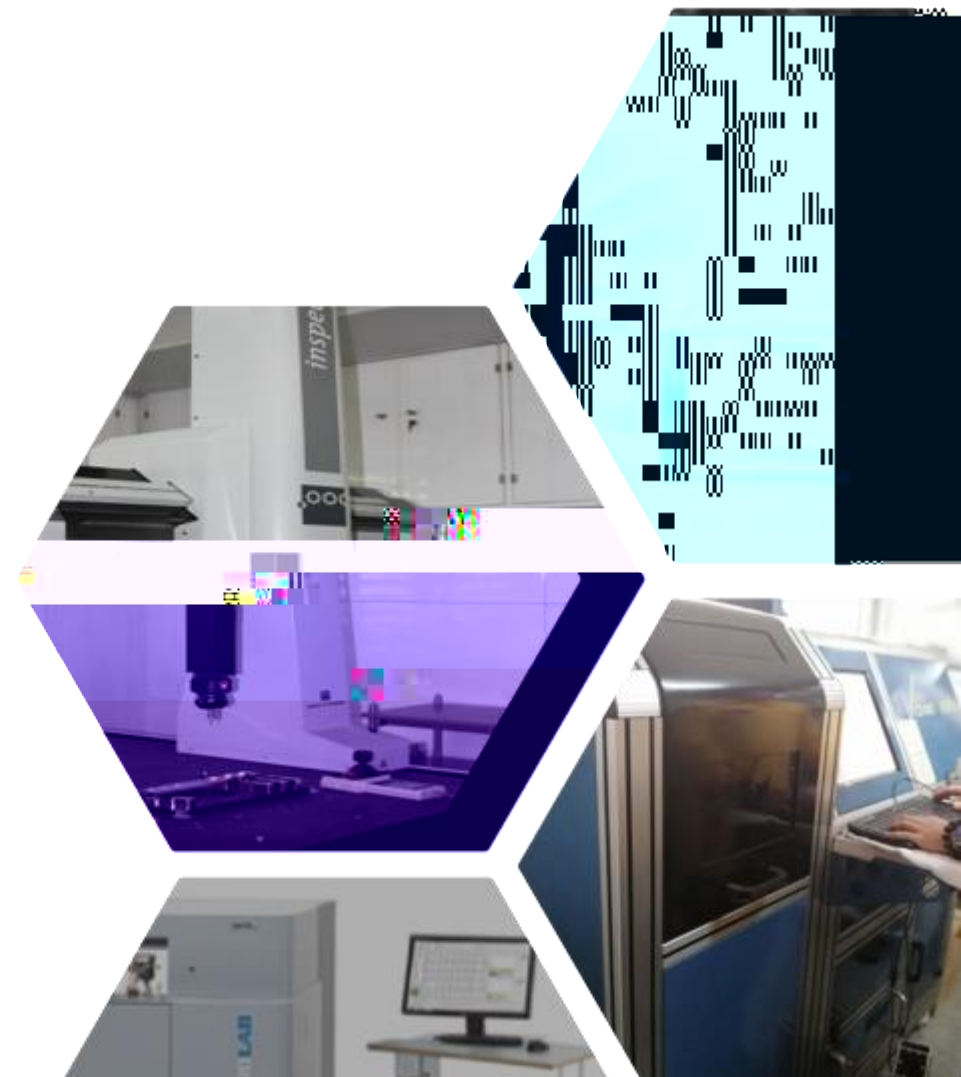

MIG\FSW

